

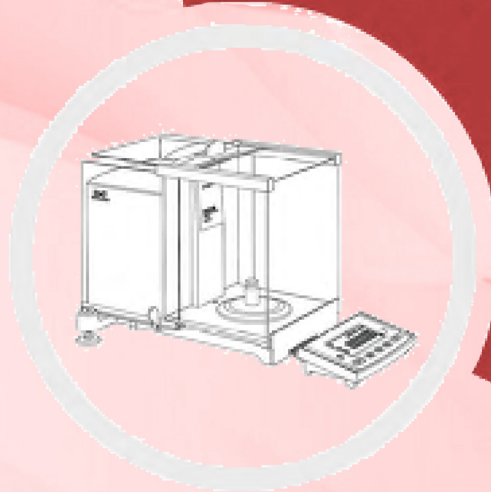



















OUR
PRODUCT



Exzellenz Series
Weighing Balances

Type	Series	Model	Picture	1µg	0.01mg	0.1mg	0.2mg	1mg	5mg	0.01g	0.1g	
Precision Electronic Balance / Excellence II Balance	Exzellenz	XZ-A						120g 220g 320g 420g 520g 620g 820g 1020g				
		XZ-B								1200g 2200g 3200g 4200g 5200g 6200g 8200g 10200g		
	XS	XS-A						120g 220g 320g 420g 520g 620g 820g 1020g				
		XS-B								1200g 2200g 3200g 4200g 5200g 6200g 8200g 10200g		
Analytical Balance / Semi-micro Balance	Exzellenz	XZ-E			31g 51g 82g 120g	120g 210g 220g 320g						
		XZ-J				120g 220g						
	XS	XS-E			31g 51g 82g 120g	120g 210g 220g 320g						
		XS-J				120g 220g						
Micro Balance	Exzellenz	XS-H		2.1g 5.1g	30g							
Industrial Balance	XS										8kg 12kg 16kg 20kg 30kg	
Special Balance	Jewelry Balance (Carat Balance)	XZ					60g (300ct) 120g (600ct)					
		XS					60g (300ct) 120g (600ct)					
	Paint-mixing Balance	XS-P									5kg 8kg 10kg 20kg 30kg	
	Check Weighing Balance									3200g 4100g 5000g		
	Density Balance	XZ-D					120g 210g		120g 200g 310g 410g			
		XS-D					120g 210g		120g 200g 310g 410g			
Moisture Analyzer	Exzellenz	XZ-F				120g/0.1mg/0.001%		120g/1mg/0.01%				
	XS	XS-F				120g/0.1mg/0.001%		120g/1mg/0.01%	120g/5mg/0.01%			
On-line Weighing and Module	XS	XS-L				120g 200g		320g		3200g	10kg	

0.5g	1g	2g	10g	20g	Range of Application
					Precision weighing in laboratory and production environment.
					Analysis and inspection of micro samples. With ultra high resolution.
					Quality control in laboratory, chemical laboratory, medical device research, etc.
50kg 60kg	100kg 150kg	200kg 500kg	1000kg	2000kg	Weighing in industrial measurement, special metal alloys, special parts, etc.
					Precision weighing in precious metals and jewelry.
					Auto repair, paint-mixing coating-mixing, etc.
					3 color sound and light alarm, upper and lower limits can be set freely. (applicable to the quality inspection of the production process)
					Rubber, wire and cable, aluminum products, PVC pearls, etc.
					Testing free water for food, feed, paper making, tobacco and other industries.
					Lithium battery production, electronic parts, pharmaceutical production and packaging, oil and other industries.

Precision Electronic Balance / Excellence II Balance

Analytical Balance / Semi-micro Balance

Micro Balance

Industrial Electronic Balance

Special Balance

Density Balance

Moisture Analyzer

Mass Comparator

On-line Weighing and Module

Mass Comparator

Mass comparator, a special type of electronic balance, is mainly used for quality comparison of weight and sample under high requirement of accuracy. Mass comparator is mainly used in verification of weights, national standard quality laboratories, statutory metrological verification institutions, calibration laboratories, etc.



Mass Comparator

Mass Comparator

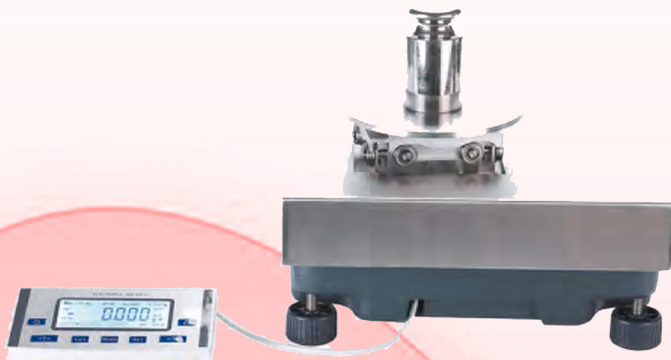

Product overview >

Mass comparator, a special type of electronic balance, is mainly used for quality comparison of weight and sample under high requirement of accuracy. Usually mass comparator can not display the real weight value of weight, but the weight gap between weight or sample to be weighed and standard weight or sample. With the known quality value of standard weight, the weight gap between the to be weighed and the standard can be obtained and then the real weight value of the weighed can be calculated accordingly. Owing to the extremely high resolution and excellent repeatability, accurate weight value of the to be weighed can be guaranteed by mass comparator in spite of tiny gap between the to be weighed and the standard can be obtained and then the real weight value of the weighed can be calculated accordingly.

Scope of application >

Mass comparator is mainly used in verification of weights, national standard quality laboratories, statutory metrological verification institutions, calibration laboratories, etc. Mass comparator is now playing more and more important role in the field of industrial quality control, for instance, measurement of standard density and volume, coating abrasion owing to mechanic factors, weighing of filter memberane and coating in chemical industry, filling weighing of valuable gases and turbine blades weighing.

Main feature >

- ◇ Extremely high resolution and excellent repeatability;
- ◇ Standard RS232 interface for bidirectional communication;
- ◇ Quality comparison of weight ranging from mg to ton;
- ◇ Calibration of F1 grade weight and below;
- ◇ Optional advanced automatic loading function will guarantee repeatability;



Optional capacitive touch screen

Intuitive interface and quick icon menu navigation. Help users to simplify the work process and eliminate human error.



RS232 communication interface

Realized bidirectional communication between balances and computers, printers, PLC and other external devices.

Automatic centering weighing pan

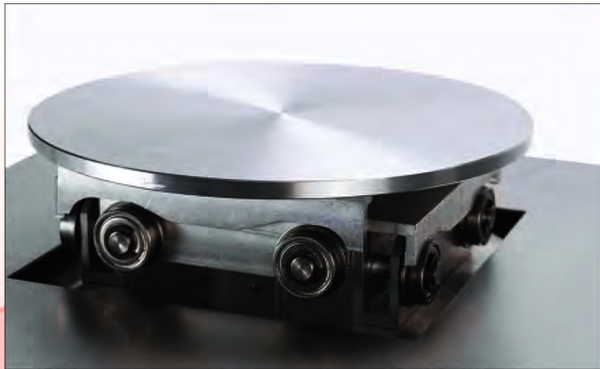

- Enhanced weighing accuracy;
- Eliminated deviation from unbalancing loading;
- Located all types of items to the center of gravity accurately;
- No need to adjust the location of weight on the weighing pan.

Electromechanical separation design



- Removable, detachable display operation terminal, easy to operate;
- Isolated noise from electrical equipment avoid interference to sensible analogous circuit;
- Shorter stabilization time enhanced repeatability;
- Guaranteed weighing accuracy.

Mass Comparator Parameter: ▶

For verification of F1 grade weight
(weight excluded, customized if required)



Model	Max.Capability	Readability	Repeatability
XS504F1	500g	0.2mg	0.4mg
XS1KF1	1kg	0.5mg	0.8mg
XS2KF1	2kg	1mg	1.6mg
XS5KF1	5kg	2mg	4mg
XS10KF1	10kg	5mg	8mg
XS20KF1	20kg	10mg	16mg
XS50K	50kg	20mg	32mg

For verification of F2 grade weight
(weight excluded, customized if required)



Model	Max.Capability	Readability	Repeatability
XS504F2	500g	0.5mg	1.3mg
XS1KF2	1kg	1mg	2mg
XS2KF2	2kg	2mg	4mg
XS5KF2	5kg	5mg	13mg
XS10KF2	10kg	10mg	25mg
XS20KF2	20kg	20mg	50mg
XS1KF2-2	1kg/1mg	500g/0.5mg	2mg/1.3mg
XS2KF2-2	2kg/2mg	1kg/1mg	4mg/2mg
XS5KF2-2	5kg/5mg	2kg/2mg	13mg/4mg

For verification of M1 grade weight and below
(weight excluded, customized if required)



Model	Max.Capability	Readability	Repeatability
XS1KM1-2	1kg/5mg	500g/2mg	8mg/4mg
XS1KM1	1kg	5g	3mg
XS1KM1-1	1kg	2mg	4mg
XS20KM1-2	20kg/0.1g	10kg/0.05g	0.16g/0.05g
XS21KM1	20kg	50mg	100mg
XS25KM1	25kg	100mg	200mg
XS1TM1	1000kg	5g	8g
XS2TM1	2000kg/10g	1000kg/5g	16g/8g